



INSTRUCTION MANUAL

**space** EXTENDER  
OCEANREEF®



WE WERE ALL BORN FROM THE SEA.

Maybe that's why we're so irresistibly attracted to it.

As soon as we're immersed in it, once again we turn to breathe, we feel we're back to our true natural setting.

In our every effort, every thought, every dream, the sea finds its way.

We yearn to be back in it to better observe it, to admire its grandness, always with new eyes.





To be back in it, to be astonished by it and to share its wonders with our friends.

To be back in it, to imbue new life to the very place that's been witness to the birth of all.

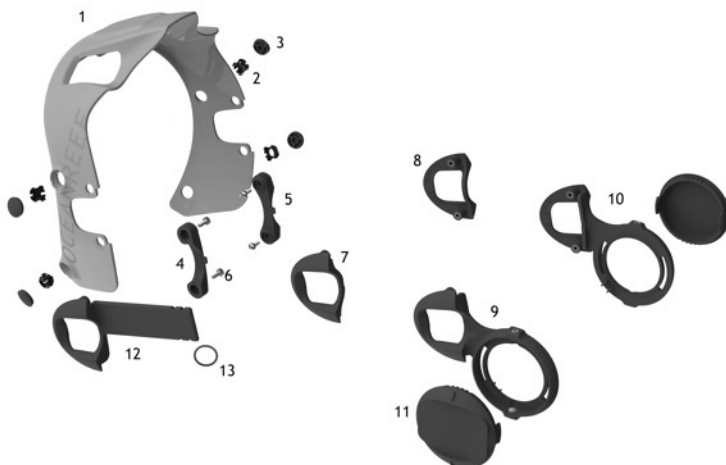







**OCEANREEF®**  
underwater, naturally.

## PARTS LIST



Number	Name	Quantity	Picture
1	Frame	1	
2	Bushing	4	
3	Bushing Cover	4	
4	L Bridge	1	
5	R Bridge	1	

## EXTENDER INSTRUCTION MANUAL 2016

6	M3 screw	4	
7	L Neutral	1	
8	R Neutral	1	
9	L Earphone support	1	
10	R earphone support	1	
11	Earphone plug	2	
12	Comm support (New NACS)	1	
13	Oring 117	1	

**Extender frame, kit and accessories are compatible with all Gdivers IDMs, Neptune Space 2006 IDMs onward, Raptor IDMs.**

## Extender Product Options

### (EXTENDER FRAME) - In the box

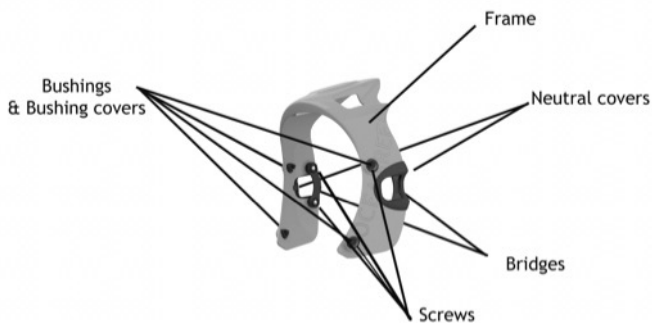

### (EXTENDER KIT) - in the box

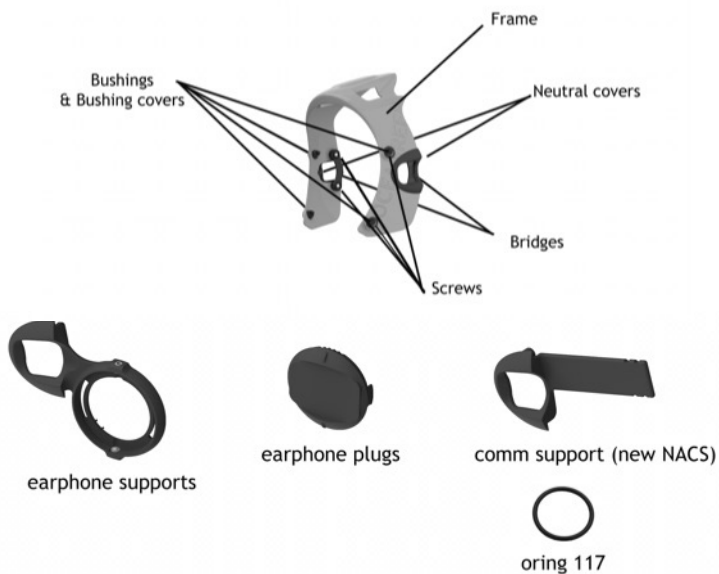

(SPACE EXTENDER) - in the box



IDM + Extender  
frame, assembled



earphone supports



earphone plugs



comm support (new NACS)



o-ring 117

## ASSEMBLY

**STEP 1.**



*Parts 1 + 4 + 5 + 6 + 7 + 8*



Look for  
L and R indications on  
Parts 7 and 8.

Small flap inside of the  
Frame.



**STEP 2.**

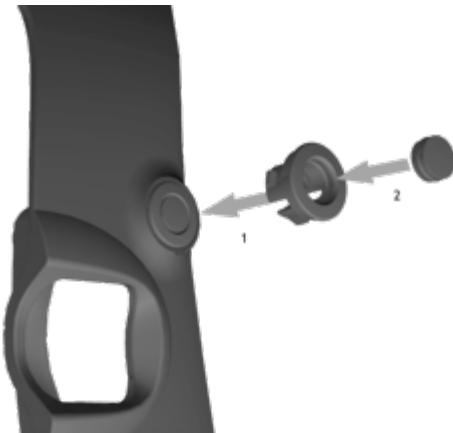

*Parts 2+3*





*CLICK Extender Frame Assembled*

**STEP 3.**



*4x Straps must pass inside the frame, through the holes.*

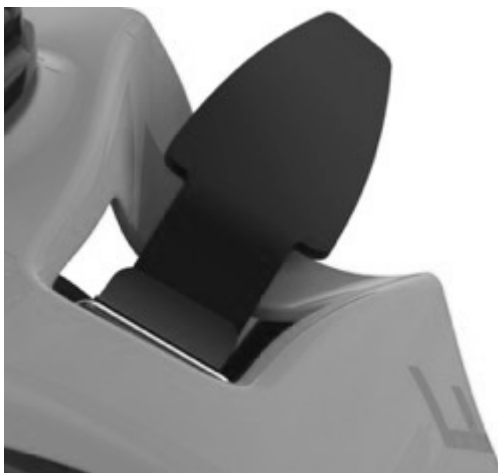



*IDM with assembled frame (straps detail).*

**STEP 4.**



**CLICK!**

**X4**

**Assemble frame on mask.**

## EXTENDER KIT & SPACE EXTENDER Communication Support

Assembling the new NACS system (communication device support). Compatible with all GSM models (communication units not included).

### *STEP 1*



*Parts 1+12+4+6.*

STEP 2



Part 13



*IDM + new NACS + comm unit.*

## ACCESSORIES

Assembling multipurpose rotating support + new MHA-2. Multipurpose support can mount accessories and MHA-2, simultaneously.

### *STEP 1*



Parts 1+4+5+6+9+10.

**STEP 2**

Add GSM GPower SL comm unit (not included); Add new MHA-2 earphones (not included) or MHA-2 earphones as with new GSM GPower SL.



*Secure ear-  
Phones with  
Orings*



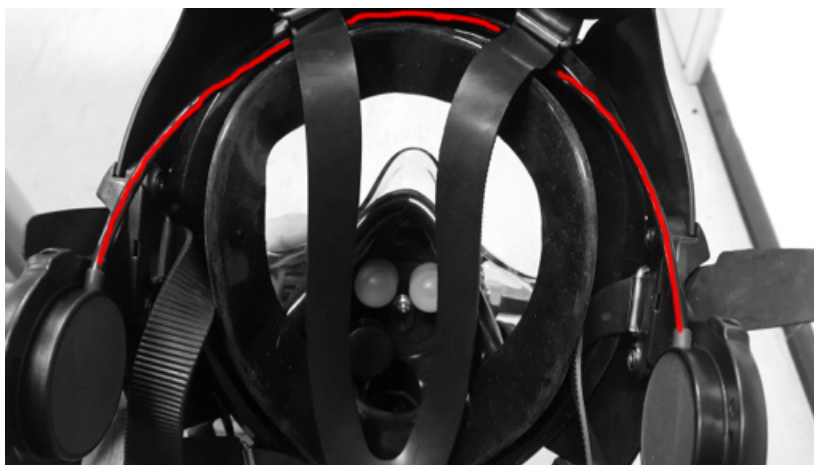
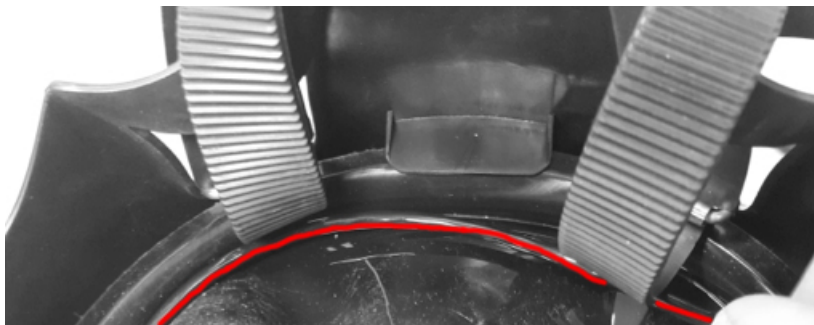

*Place wire under straps and above face seal following contour.*

*Hold cable in place with 3<sup>d</sup> Oring - as shown.*







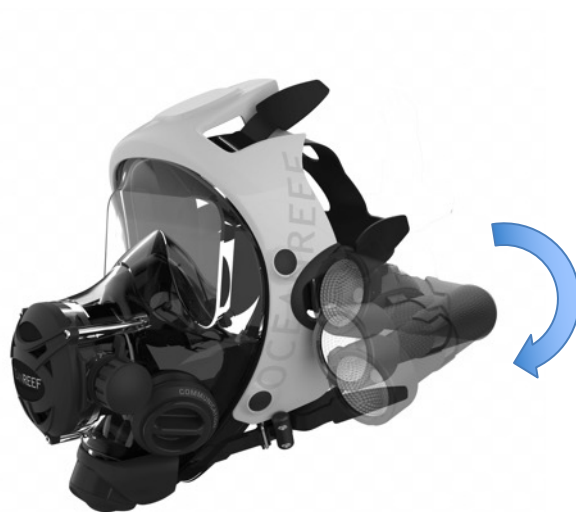

*Extender IDM + MHA-2.*

**STEP 3****Assembling earphone plug (multi purpose surface)****CLICK!***Parts 11****Rotates 30°  
Click,click,click***

Extender Frames Available colours.



Accessories can be mixed mounted as shown.



*2 slight position holes signal where part number 12 can be drilled to create personalized mounts for accessories.*



## CAUTIONS AND WARNINGS

- Do not use solvents (such as diluents) to clean the product. They can cause irreparable damage. Only use neutral detergents.
- Rinse the product thoroughly after each use with fresh water.
- Store in a cool, dry place.
- Don't expose to extreme low or high temperatures.



The frame does not serve as a helmet and is not intended to prevent injuries.



The warranty and OCEAN REEF do not cover or approve directly of any modification or alteration occurred to the products by the customer.

## WARRANTY

1. OCEAN REEF products are guaranteed to be free of material or manufacturing defects for a period of 24 months from the time the product is purchased. For the duration of the guarantee, the Company's responsibility is limited to replacement of any parts that are defective in our opinion, and that have not been used incorrectly or handled negligently. The unit must be returned to the outlet from which it was bought, along with proof of purchase.
2. Even during the guarantee period, this guarantee shall not be valid where:
  - Damage was caused by incorrect handling or carelessness.
  - Damage was caused by the product negligently handled after it was purchased.
  - Damage caused by fire, earthquake, floods, lightning, or other natural disasters, pollution or electrical charges.

### Extender product line codes

	<b>Black</b>	<b>White</b>	<b>Yellow</b>	<b>Orange</b>	<b>Green</b>
<b>FRAME</b>	OR025050	OR025054	OR025051	OR025052	OR025053
<b>KIT</b>	OR025040	OR025044	OR025041	OR025042	OR025043

	<b>Size</b>	<b>Kit color</b>	<b>Code</b>
<b>Space Extender Black face seal</b>	S/M L/XL	Black Black	OR025102 OR025103
<b>Space Extender Orange face seal</b>	L/XL	Black	OR025105
<b>Space Extender Yellow face seal</b>	L/XL	Black	OR025104
<b>Space Extender 100 black face seal</b>	S/M L/XL	Black Black	OR025100 OR025101

Mestel SAFETY s.r.l.  
Via Arvigo 2, 16010 Genova (Italy)  
Ph. +39 0106598611 Fx. +39 0106598622  
Email: [ocean.reef@oceanreefgroup.com](mailto:ocean.reef@oceanreefgroup.com)

OCEAN REEF Inc.  
1699 La Costa Meadows Dr. Suit 101, San Marcos, CA  
92078 United States  
Ph. +1 7607449430 Fx. +1 7606449525  
Email: [operator@oceanreefgroup.com](mailto:operator@oceanreefgroup.com)

OCEAN REEF on the web  
[www.oceanreefgroup.com](http://www.oceanreefgroup.com)

SAFETY and OCEAN REEF are companies of the  
Ocean Reef Group

© OCEAN REEF 2016

